

MPPT HYBRID BOOST CHARGE CONTROLLER Rev.1

USER MANUAL

INSTALLATION – OPERATION



November2021

HYBRID BOOST CHARGE CONTROLLER Rev.1 - MPPT

Congratulation! You have bought a high-quality hybrid charge regulator.

The [Hybrid Boost Charge Controller](#) is specially developed for the Silentwind generator.

The Warranty Terms are described in a chapter of this manual. For traceability under the warranty, please register the [Hybrid Boost Charge Controller](#) on our website: www.silentwindgenerator.com

Registering your [Hybrid Boost Charge Controller](#) has the following benefits:

- Confirmation of your ownership and safety notifications: by keeping a record of your registration, we will be able to trace your product and contact you quickly if necessary;
- Product information news: choose to be among the first to hear about our latest product, helpful advice or product developments

If you have any questions or comments, do not hesitate contact us:

Kab Connect Unip., Lda
Loteamento Industrial de Linhares, Lote 19
PT-4805-486 Santo Estevão de Briteiros / Guimarães
Portugal

Phone: 00351-253-572763

Fax: 00351-253-572764

E-mail: info@silentwindgenerator.com

Business Hours:

Monday to Friday: 8h00 to 17h00 GMT + 0:00

Welcome to Silentwind family!



The CE marking is a mandatory compliance requirement in EMEA and the UK and although it is self-certified, testing and evidence to support that testing is preferred from an independent test house.

Machinery Directive 2006/42/EC, Electromagnetic Combability Directive 2014/30/EC. The report and the declaration of conformity are available for inspection on request.

Index

1. IMPORTANT SAFETY WARNINGS AND PRECAUTIONS	6
2. PRESENTATION	7
3. TECHNICAL DATA	8
3.1 HYBRID BOOST CHARGE CONTROLLER– ELECTRICAL DATA.....	8
3.2 HYBRID BOOST CHARGE CONTROLLER - MECHANICAL DATA.....	8
3.3 INSTALATION NOTES	8
3.4 PRODUCT STRUCTURE.....	9
3.5 LCD INFORMATION	10
3.6 LCD DISPLAY	12
3.7 LOAD OUTPUT MODES.....	13
4. SAFETY PRECAUTIONS.....	13
5. INSTALLATIONS	14
5.1 PACKAGE	14
5.2 RECOMMENDATIONS.....	14
5.3 REQUIRED TOOLS AND EQUIPMENT	14
5.4 CABLES AND FUSES	15
5.5 PHYSICAL INSTALLATION	16
5.6 ELECTRICAL INSTALLATION	17
5.6.1 SOLAR PANELS.....	18
5.6.2 SILENTWIND GENERATOR.....	21
5.7 SETTINGS	21
5.7.1 SCAN BUTTON	22
5.7.2 SILENTWIND CONTROLLER APP	24
5.8 CHECK LIST	26
6. OPERATION	26
7. RESET.....	27
8. TROUBLESHOTTING	28
8.1 No display on LCD.....	28
8.2 No output	28
8.3 No charging	28
9. WARRANTY	30

1. IMPORTANT SAFETY WARNINGS AND PRECAUTIONS

Before using the controller, please read all instructions and cautionary markings on the unit and this manual. Print or save the manual where it can easily be accessed.



- Please study the information thoroughly before starting to install the [Hybrid Boost Charge Controller](#).
- This manual should always be kept near the [Hybrid Boost Charge Controller](#).
- Silentwind cannot be held liable for any direct or indirect loss or damage, due to an incorrect operation or improper device handling.
- To avoid a risk of fire and electric shock, make sure the existing wiring is in good conditions and that the wires are connected tightly
- Do not disassemble the [Hybrid Boost Charge Controller](#). Warranty will void.
- Never attempt to repair or disassemble the [Hybrid Boost Charge Controller](#) or its parts as there is a danger of fire, electrical shock and possibly death.
- Do not change the electrical components and parts by yourself, only Silentwind's authorized technicians are able to repair the [Hybrid Boost Charge Controller](#).
- Wrong settings can permanently damage your batteries, your charge controller and your wind generator.



Always download the up-to-date manuals. Manuals may change without prior notice.

2. PRESENTATION









The [Hybrid Boost Charge Controller](#) is a combined wind and solar charge regulator with an inbuilt micro-controller. The [Hybrid Boost Charge Controller](#) enables you to install the Silentwind generator and solar panels to a maximum power of 300 Watt (peak), that are connected to the deep cycle output can be automatically switched OFF or ON by a deep cycle protection function.

All operation parameters can be seen on an LCD-display or on a tablet or smartphone over the wireless connection (Bluetooth). You can set all operating parameters directly on the [Hybrid Boost Charge Controller](#) or over the Silentwind APP available for Android and iOS devices.

The Silentwind generator is a 3 phase AC voltage and in the [Hybrid Boost Charge Controller](#) AC is transformed to DC voltage. The voltage of the Silentwind generator and the [Hybrid Boost Charge Controller](#) must be chosen in accordance with the system voltage.

All types of batteries (Gel, AGM, Acid and Lithium) can be charged.

The [Hybrid Boost Charge Controller](#) features:

-  Wind MPPT point adjustable.
-  Solar and Wind - Hybrid charge controller.
-  Integrated electronic brake – charge limitation and storm brake.
-  LCD-display of all relevant working data: W, A, V, Ah.
-  Seven models of load output settings (not available on 48V version).
-  Cable connections - screw terminals.
-  Wireless communication
-  External wireless antenna for a wider wireless range

3. TECHNICAL DATA

3.1 MPPT HYBRID BOOST CHARGE CONTROLLER– ELECTRICAL DATA

System voltage	12 VDC / 24 VDC / 48 VDC
Max. power input wind generator	600 Watt
Max. current input of the wind generator	40 A / 30 A / 15 A
Max. power input solar	300 Watt
Max. current input solar	20 A / 10 A / 5 A
Max. open circuit voltage input of the solar panel	48 VDC / 48 VDC / 96 VDC
Max. total charge current	60 A
Max. switch off current at LOAD-output (Load)	2 x 10 A
Max. voltage adjustable for the battery types	Acid, Gel, AGM and Lithium
LCD + LED displays	W, A, V, Ah

3.2 MPPT HYBRID BOOST CHARGE CONTROLLER - MECHANICAL DATA

Weight	2.30 kg
Package dimensions	220 x 150 x 83 mm
Cover protection class	IP52

3.3 INSTALATION NOTES









The machine should be kept indoors and well ventilated	
Environment temperature	-20 °C - +40 °C
Altitude	< 1000 m
The space around the device has no other items within	30cm
Can only charge batteries in the same rated voltage range	
The charge controller can only be connected to the wind turbine and the PV in the same rated voltage range	





3.4 PRODUCT STRUCTURE







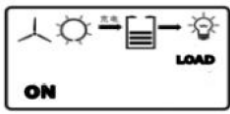

1	LCD Display
2	Brake light
3	Button
4	Temperature compensation sensor connector
5	Battery terminals
6	Silentwind terminals
7	Solar Panel terminals
8	Load terminals
9	External Antenna connector
10	M4 screw install hole

3.5 LCD INFORMATION

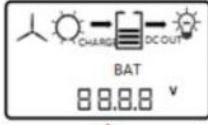
Name	Icon	Status
Wind turbine		Rotate means wind turbine works normally.
	BRAKE	Brake by hand.
Solar		Day.
		Night or Panel Solar is not connected.
Battery		Charging.
		Fully charged. Flickering for over voltage. Stop flickering when it recovers from over voltage.
		Flickering means over-discharge.
Load		Output normally.
		No output. Flickering for overload.
		Flickering means short circuit.

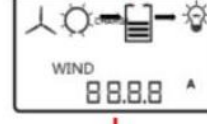
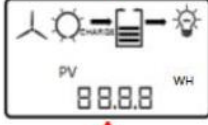
Name	Icon	Status	
Load output		Light control on/off.	
		Light control on, time control off.	
	ON 88.88 v	Light control on voltage.	
		When "ON" & "LOAD" appeared, load is always on.	
	OFF 88.88 v	Light control off voltage.	
		Show "OFF" and time. The time is the control off time.	
Control mode	1、2	Show 2 loops relatively.	
	Others	88:88	Parameters display.
		"SET"	Set icon. When it appears, you can set related parameters by press the browse button.
Unload indicator light		When the machine is in unload or brake status, the indicator light is red. The light is off when it operates normally.	

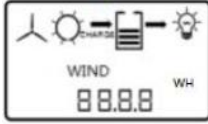
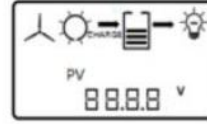
3.6 LCD DISPLAY

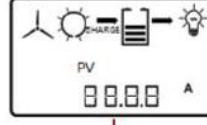
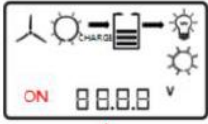
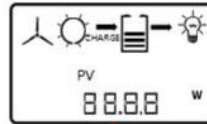
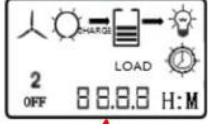
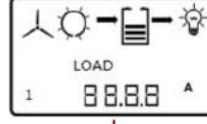
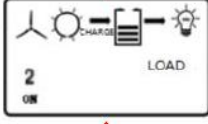
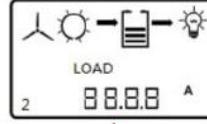
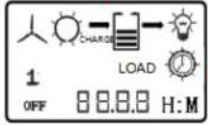
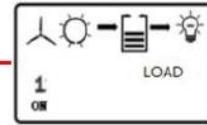
Interface Introduction	Display Interface	Interface Introduction
Battery Voltage	 → 	Wind turbine Voltage
Accumulative total electricity consumption	 ↑ 	Wind turbine Current
Accumulative total Solar generation capacity	 ↑ 	Wind turbine Power
Accumulative total wind turbine generation capacity	 ↑ 	Solar Panel voltage
Light control off voltage	 ↑ 	Solar Panel current
Light control on voltage	 ↑ 	Solar Panel power
*Load 2 Control off Time	 ↑ 	Load 1 current
Load 2 output mode	 ↑ 	Load 2 current
*Load 1 off time	 ← 	Load 1 output mode

* It will only be displayed if the setting is turned On.

3.7 LOAD OUTPUT MODES

Load output modes optional that can be set on the LCD display or software

V1	Light control on / off	V2	Light control on, time control off
V3	Light control on/off, time half power	V4	Light control on, time half power, time control off
V5	Constant On	V6	Constant Off
V7	Constant half power		

4. SAFETY PRECAUTIONS

Our primary concern when we developed the [Hybrid Boost Charge Controller](#) was your safety. The information provided is to ensure your safety during installation, operation, and in case of trouble.

- ✚ Avoid using the [Hybrid Boost Charge Controller](#) in direct sunlight, sun exposure, rain, humidity, acid fog and dust.
- ✚ Do not use the [Hybrid Boost Charge Controller](#) in a place where has flammability and explosive gas/articles. Beware of flames and sparks.

If you have any additional questions, please contact us.



Please keep in mind that liquid acid batteries can emit dangerous explosive gas. If the place where the [Hybrid Boost Charge Controller](#) is installed is close to this kind of batteries, ensure that has efficient ventilation.

WHEN WORKING IN THE SYSTEM:



1st Disconnect the Silentwind generator (to avoid risks, once you remove the 3 wires from the generator, please put at least 2 wires from the generator together to cause a short circuit and slow down the rotation of the blades).

2nd Disconnect the solar panels if available.

3rd Disconnect Battery. This is very important. Otherwise the [Hybrid Boost Charge Controller](#) will be damaged.

5. INSTALLATIONS

Before installation the [Hybrid Boost Charge Controller](#), find a suitable position indoor to avoid water entering the controller. The [Hybrid Boost Charge Controller](#) must be installed in a place with good ventilation and heat dissipation.

Plan your installation carefully.





Follow the correct assembly sequence:









- 1st Charge controller to battery connections
- 2nd Solar Panels to the charge controller
- 3rd Wind generator to the charge controller

5.1 PACKAGE





The package includes:

-  1 unit - Charge controller
-  1 unit - External Sensor cable
-  1 unit – External antenna

5.2 RECOMMENDATIONS

-  Make sure all wires are placed in the correct position or it will damage the charge controller.
-  The three AC cables need to have the same cross section and the correct mm²/AWG.
-  A damaged cable is a severe safety risk. Wires with inadequate cross section can cause fire.
-  Make sure the electrical connections (crimping) are done 100%.
-  Any voltage drops can influence the control of brake functions.
-  Use tinned copper cables for marine installations.
-  When connecting the [Hybrid Boost Charge Controller](#) to the battery, sparks can occur.
-  A short circuit is to be avoided.
-  Always ensure enough ventilation in battery location.

5.3 REQUIRED TOOLS AND EQUIPMENT

-  Cable with the required length and diameter to connect the three AC phases from the Silentwind generator to the [Hybrid Boost Charge Controller](#).
-  Connectors for the three-phase cables to connect to the wind generator.
-  Red and black cable to connect the [Hybrid Boost Charge Controller](#) to the battery.
-  Joint connector for battery cable.
-  Fuse.



The proper cable sections are listed in the following chapter.

5.4 CABLES AND FUSES

The required cross section of the wires depends on their length and the rated voltage of your system. Select the location of the mast and measure the distance from the mast top to the battery. Select the minimum cross section required in the basis of the following tables. The three AC cables need to have the same cross section.

System voltage 12 Volt

Distance from wind generator to the charge controller (m)	0 - 9	10 - 19	20 - 29	30 - 44	45 - 69	70 - 110
Cable cross section mm ² - AWG	6 - 10	10 - 8	16 - 6	25 - 4	35 - 2	50 - 1
Distance from the charge controller to the battery (m)	0 - 9	10 - 19	20 - 29	30 - 44	45 - 69	70 - 110
Cable cross section mm ² - AWG	16 - 6	24 - 4	35 - 2	-	-	-

System voltage 24 Volt

Distance from wind generator to the charge controller (m)	0 - 9	10 - 19	20 - 29	30 - 44	45 - 69	70 - 110
Cable cross section mm ² - AWG	2.5 - 14	4 - 12	6 - 10	10 - 8	16 - 6	25 - 4
Distance from the charge controller to the battery (m)	0 - 9	10 - 19	20 - 29	30 - 44	45 - 69	70 - 110
Cable cross section mm ² - AWG	16 - 6	25 - 4	35 - 2	-	-	-

System voltage 48 Volt

Distance from wind generator to the charge controller (m)	0 - 29	30 - 79	80 - 99	100 - 150
Cable cross section mm ² - AWG	2.5 - 14	4 - 12	6 - 10	10 - 8
Distance from the charge controller to the battery (m)	0 - 29	30 - 69	70 - 99	100 - 150
Cable cross section mm ² - AWG	4 - 12	4 - 12	10 - 8	16 - 6-

For protection against high voltage spikes and/or an accidental short-circuit event, fuses must be installed in the positive (red) wires to the battery. The required value of the fuse depends on the rated current of the Silentwind generator and solar panels connected to the [Hybrid Boost Charge Controller](#).

We recommend:

Silentwind generator	Max Current (A) (Silentwind generator + Solar Panel)	Fuse (A)
12V	40 + 20	50 + 25
24V	20 + 10	30 + 15
48V	10 + 5	20 + 10

5.5 PHYSICAL INSTALLATION

The **Hybrid Boost Charge Controller** should be installed in a wall using four screws with the panel upright (if you can read the front panel text horizontally then this is correct).

The side panels and back are a heat sink to dissipate heat, which is why the orientation is important. To guarantee the lifespan, it is suggested that the space around the device has no other items within 30cm.

1st Drill Size

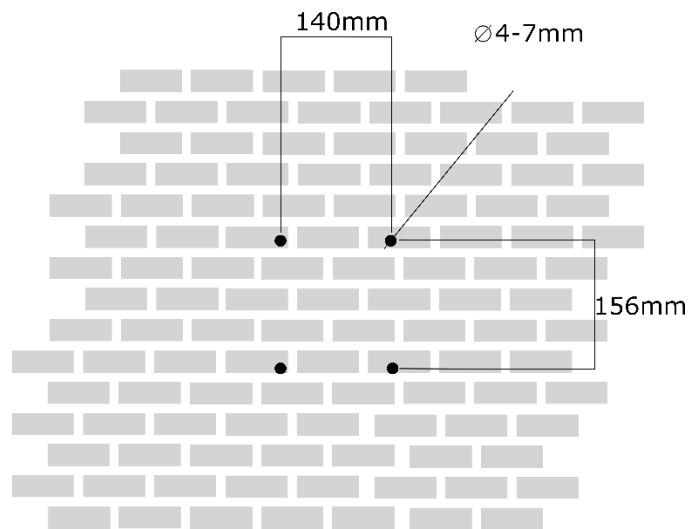

2nd Fix the controller on the wall with M4 screw

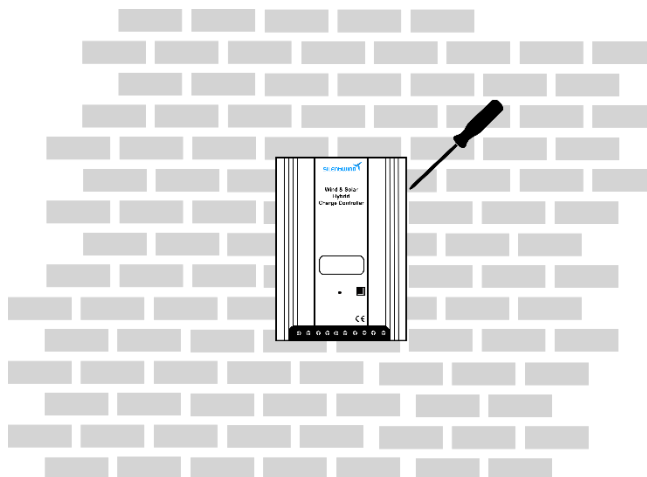

3rd When fix the screw, try to shift the screw driver about 10° angle

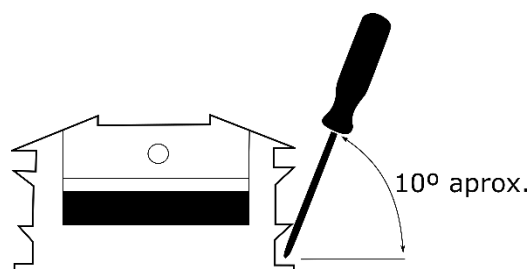

5.6 ELECTRICAL INSTALLATION

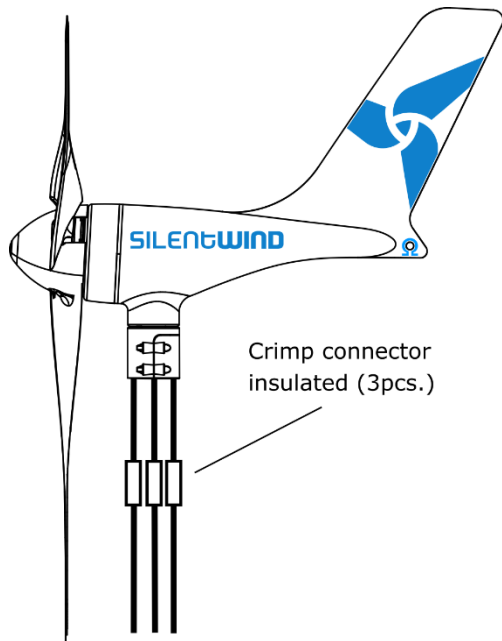

Making an extension of the 3 cables AC, using a crimp connector insulated will be necessary since the Silentwind generator will be fixed in the mast and the [Hybrid Boost Charge Controller](#) will not be fixed in the same place.



If there is enough wind speed when connecting Silentwind generator, this will immediately generate electric power at the end of the 3 AC-wires without being connected to the [Hybrid Boost Charge Controller](#). Therefore, we recommend blocking the Silentwind generator blades with a rope before connecting the wires to the [Hybrid Boost Charge Controller](#).



Install a fuse between the [Hybrid Boost Charge Controller](#) and the battery positive pole as close as possible to the battery.

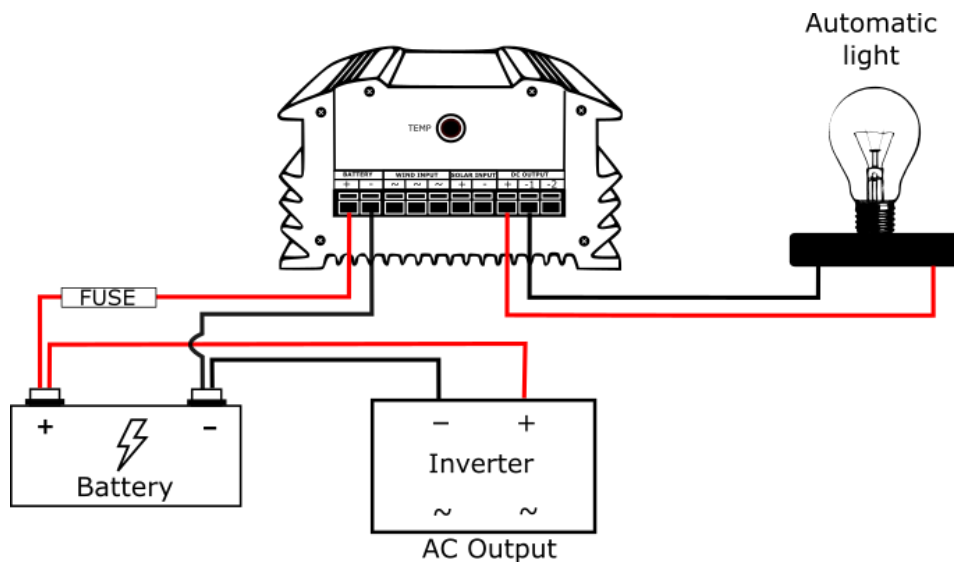

It is most important that you first connect the [Hybrid Boost Charge Controller](#) to the battery with the right polarity. The confusion of plus (red) and minus (black) will definitely destroy your [Hybrid Boost Charge Controller](#).

After the connection of the battery you can connect the solar panel, the Silentwind generator and if required, a Load Output with 10A maximum on Output 1 and 10A on Output2 with 10A maximum.

5.6.1 SOLAR PANELS

Connect the terminals of solar panels to “SOLAR INPUT” terminals “+” and “-” on the [Hybrid Boost Charge Controller](#).



All Solar panels rated voltages on this chapter are open circuit voltages (Voc). Check your solar panels datasheets for detailed information.



Do not exceed your charge controller’s maximum wattage, voltage and amperage.

12 Volt System

SINGLE PANEL

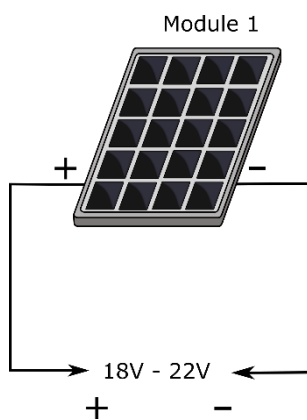

PARALLEL CONNECTION

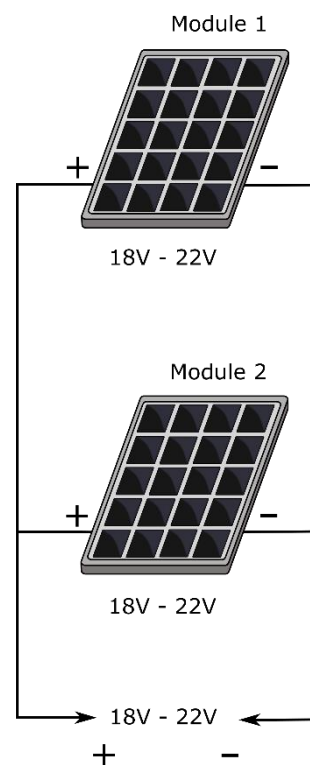

24 Volt System

SINGLE PANEL

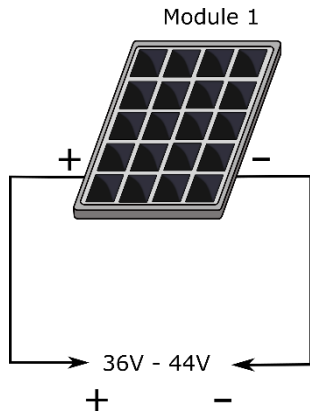

PARALLEL CONNECTION

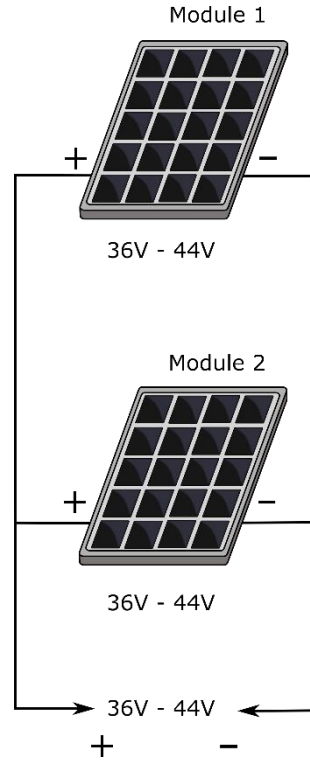

12V PANELS – SERIAL AND PARALLEL CONNECTION

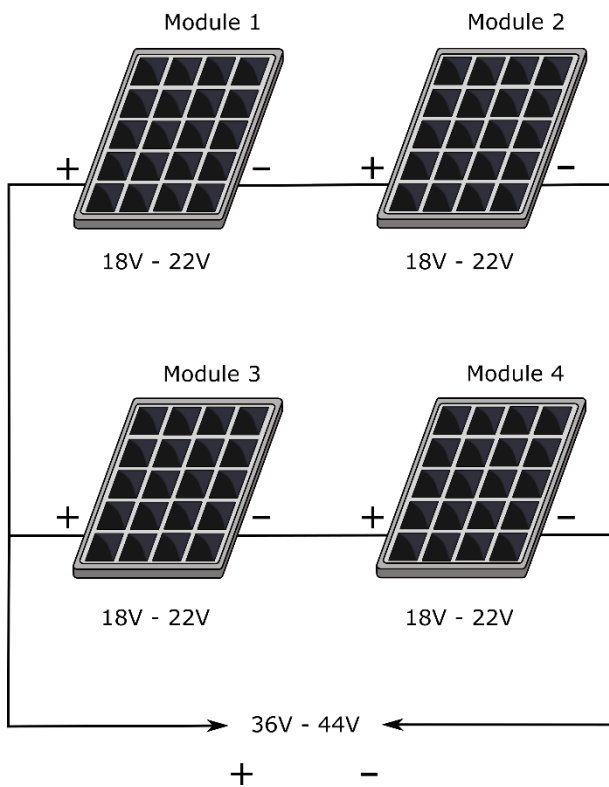

48 Volt System

24V PANELS - SERIAL AND PARALLEL CONNECTION

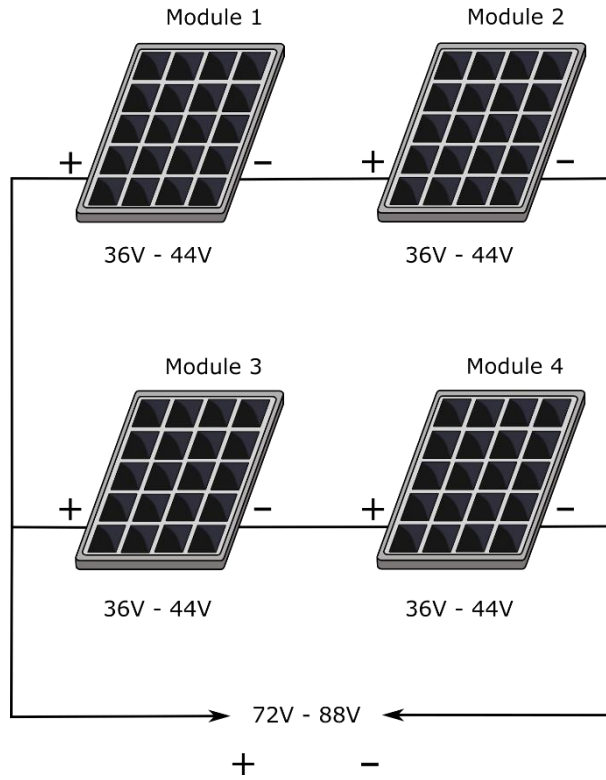

12V PANELS – SERIAL CONNECTION

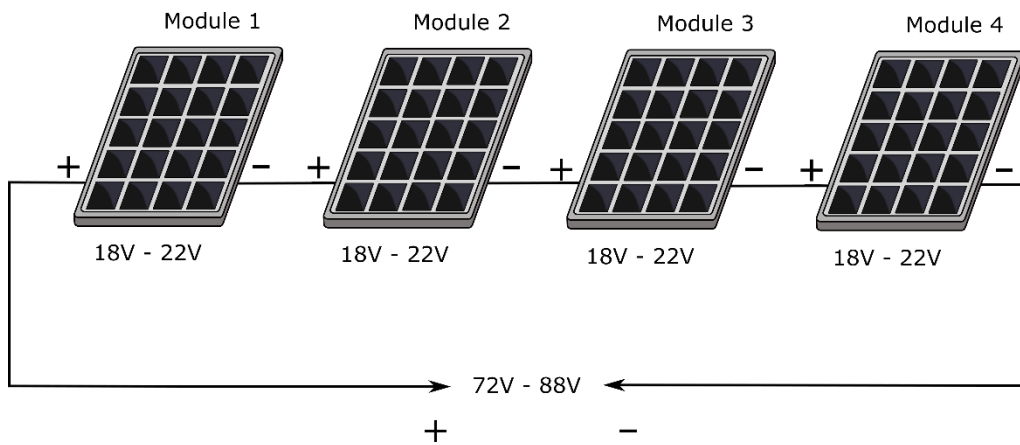

5.6.2 SILENTWIND GENERATOR

The 3 AC output wires must be connected to the 3-screw terminal on the back of the [Hybrid Boost Charge Controller](#). In a 3 phase AC system the connection order/polarity does not matter.

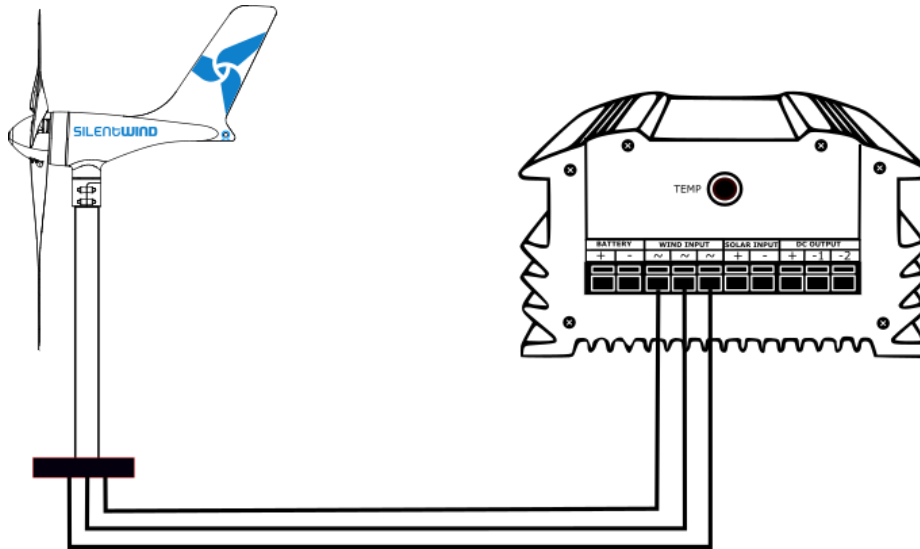

5.7 SETTINGS

The [Hybrid Boost Charge Controller](#) must be adjusted according to the type of battery and according to your individual requirements.

- ✦ **End of charge Voltage** – Batteries maximum voltage.
- ✦ **Overvoltage** – Load Output 1 and 2 Voltage protection.
- ✦ **Low Wind Boost** – set the boost to achieve an earlier start of charging in to the batteries.
- ✦ **Storm Brake** – Maximum amperage allowed. It will limit the maximum rpm speed and prevents overheating.
- ✦ **Under Voltage Switch Off** – To avoid fast discharging, below this value the Outputs are turned Off.
- ✦ **Under Voltage Recovery On** – Above this value, the Outputs are turned On.
- ✦ **Solar Switch Off** – Above this value, it will turn the Outputs Off.
- ✦ **Solar Switch On** – Below this value, it will turn the Outputs On.



The Break Adjustment of the [Hybrid Boost Charge Controller](#) generates internal rising temperatures that are thermally detected. Therefore, the break time of the Silentwind Generator will be increased in high wind speeds until the internal temperature is reduced by dissipation. For this reason, the [Hybrid Boost Charge Controller](#) should be installed on a place as cool as possible. Never install the controller at direct solar radiation or sunlight.

	Values		
	12V	24V	48V
End of charge voltage	14,4V	28,8V	57,6V
Overvoltage	16V	32V	64V
Low Wind Boost	3V	4V	10V
Storm Brake	32A	16A	9A
Under Voltage Switch Off	10,8V	21,6V	43,2V
Under Voltage Recovery On	12V	24V	48V
Solar Switch Off	1,5V	3V	6V
Solar Switch On	1V	2V	3V



The above table is for standard GEL and AGM batteries. Customers must always check the battery manufacturer settings recommendations.

The End of Charge Voltage is critical.

The Storm Brake is critical.

Silentwind cannot be held responsible for bad parameter settings that might permanently damage your batteries, your charge controller and your wind generator.

If you need to change the parameters, it can be done directly on the [Hybrid Boost Charge Controller](#) or through APP.

5.7.1 SCAN BUTTON







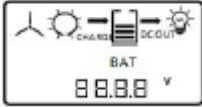
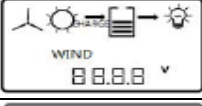
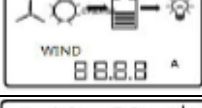
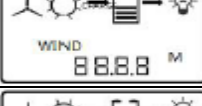

How the SCAN button works:

- ✈ Press < 1 second (1s) to change between screens
- ✈ Press for **2s** to enter SET mode (LCD shows “SET”, settings will vary according to the screen), pressing again for **2s** will exit and save the SET mode
- ✈ Pressing the scan button on SET mode will adjust the parameters
- ✈ Press de button for **5s** to turn the Brake On
- ✈ Press the button for **8s** to fix the voltage degree, and then you can enter the setting interface after it shows “24” or “12”. (Not recommended, leave it as it is – For testing purposes only)
- ✈ Press the button for **10s** to reset to factory defaults and the 8888 number will be displayed on the LCD. Stop pressing the button and then click it momentarily to turn the charge controller to normal operation.

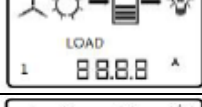

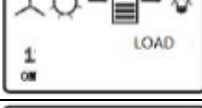
The value is looped through several parameters. So, if the value you want to set is less than the one it showed on the LCD at present, you just need increase it and let it back to the small value you need.

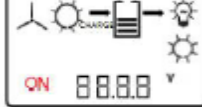
See the following table for specific parameter setting.
 Scroll down to the settings you want to change and press for **2s** to go to the desired settings.
 After setting the parameters, press for **2s** to leave the *SET* mode.

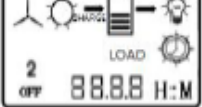
Settings	Interface Introduction	Display Interface
End of charge voltage	Battery Voltage	
Over-voltage	Wind turbine Voltage	
Storm Brake	Wind turbine current	
Do not change !!!	Wind turbine power	
Low-wind boost	Solar panel voltage	
Not enabled	Solar panel current	
Under voltage switch-off	Load 1 current	
Under voltage recovery	Load 2 current	
8 output control modes	Load 1 output mode	
Do not change !!!	Wind turbine power	
Night voltage point	Light control on voltage	
Day voltage point	Light control off voltage	
Time control duration	Load 2 control off time	

5.7.2 SILENTWIND CONTROLLER APP

The Silentind Controller APP is available on the Google Play for Android devices and Apple Store for iOS devices. Go to your app store, according the operating system of your phone, and search for: SILENTWIND.

Download the app and install it as any other APP. Compatibility information is displayed at the download section.



Please read the APP Terms and Conditions carefully.

After installing the APP make sure Bluetooth is enable in your phone and the controller is ON and near your phone.

Execute the program and follow the instructions:

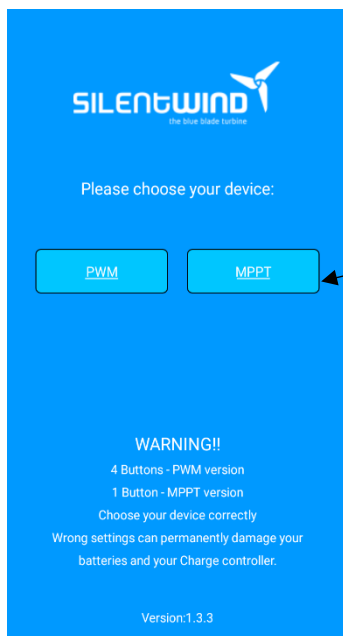

1. Choose *MPPT*

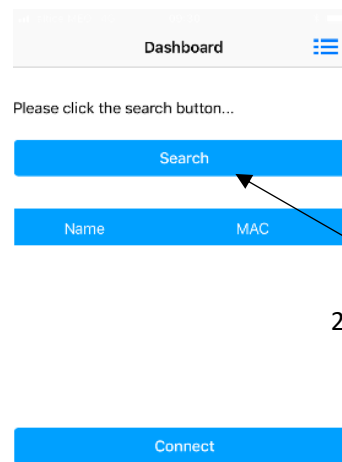

2. Click on *Search*

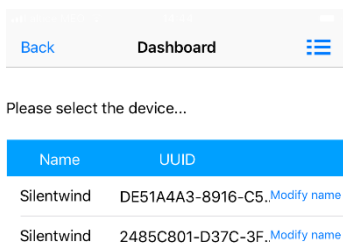

3. Choose your device



4. Click on *Connect* and wait until the dashboard is displayed

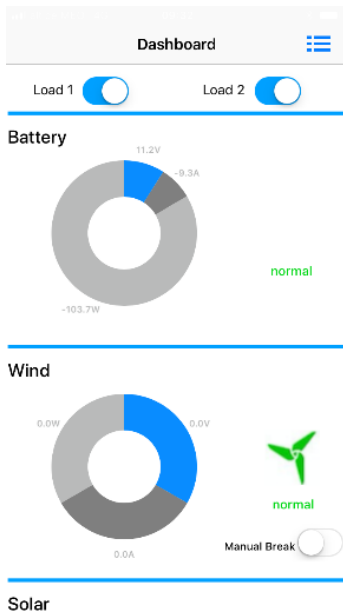

6. Click on settings

5. Set the parameters accordingly

7. Click on Save Data



The above pictures were taken from the v1.3.3 version and can differ from the present versions. For further information please visit our download section at: <https://www.silentwindgenerator.com/en/download/>

5.8 CHECK LIST

Before getting the [Hybrid Boost Charge Controller](#) started, check the correct mounting and installation according to the following check list:

Electric Installation

- Enough ventilation is provided?
- The electrical connections (crimping) were done correctly?
- All wires are correctly placed?
- The wires have the correct cross section: Silentwind generator and battery?
- The fuse was installed between the [Hybrid Boost Charge Controller](#) and the battery?

Hybrid Boost Charge Controller

- Fastened securely to the mounting location?
 - All screw terminals firmly tightened?
-

6. OPERATION

If windspeed is enough, the Silentwind generator should start charging. You can control this on the LCD display of the [Hybrid Boost Charge Controller](#) or from your smartphone or tablet using Silentwind generator APP available on Android and iOS devices.

To brake the [Hybrid Boost Charge Controller](#) manually, press the button for 5s to activate the brake status.



If the *End of charge voltage* and/or the *Brake Storm Voltage* values is/are reached, the Silentwind generator will stop for approximately 10 minutes. After that period, the charge controller will check if it's safe to turn the Brake to Off.



If the capacity of the batteries is less than 150 Ah, or old batteries that have lost their original capacity, the point of max. voltage can be reached very fast although the battery is not fully charged yet. In this case it can be useful to connect an electric consumer to the Load-output, as this will reduce the voltage and thus prevent that the break mode is activated too early.

7. RESET

Reset the [Hybrid Boost Charge Controller](#): Please press the reset button for **10s**.

Total reset of The [Hybrid Boost Charge Controller](#):



Follow the correct assembly/disassembly order.

- **How to disconnect the charge controller (wind, solar, battery):**

1st Disconnect the Silentwind generator (to avoid risks, once you remove the 3 wires from the generator, please put at least 2 wires from the generator together to cause a short circuit and slow down the rotation of the blades).

2nd Disconnect the solar panels if available.

3rd Disconnect Battery.

Following this order sequence is very important, otherwise the [Hybrid Boost Charge Controller](#) will be damaged.

- Leave the [Hybrid Boost Charge Controller](#) for at least 10 min. to rest to dissipate all energy.
- After 10 minutes connect the cables on the inverse order:

1st Connect the [Hybrid Boost Charge Controller](#) to the battery;

2nd Connect solar panels;

3rd Connect the Silentwind generator and insert the parameters again.



After a RESET, please check the parameters and adjust them accordingly.

8. TROUBLESHOOTING

8.1 No display on LCD

Description	Possible reasons and solutions
The connection between the battery and the controller is not tight.	Check the wiring and reconnect it.

Description	Possible reasons and solutions
DC breaker is not on between battery and controller.	Turn on the breaker.

Description	Possible reasons and solutions
Low battery voltage.	<ul style="list-style-type: none">- The system parameters are not matched correctly. Recheck the label and parameters on the machine.- The battery does not work. Change for a new one.

Description	Possible reasons and solutions
The battery is connected negatively to the controller.	Need change the internal fuse in controller and reconnect to the battery.

8.2 No output

Description	Possible reasons and solutions
Flicker means overload. 	Check if the load connection is normal. Remove the over load, press the set button on the load interface to recover output.

Description	Possible reasons and solutions
Load short circuit. 	Check the load and press the set button on the load interface to recover output.

8.3 No charging

Description	Possible reasons and solutions
The connection cable between wind turbine and controller is loose.	Reconnect the cable tightly.

Description	Possible reasons and solutions
Wind turbine output voltage do not reach the charging voltage.	Check if the system voltage is correct.

Description	Possible reasons and solutions
The connection cable between solar panel and controller is loose.	Reconnect the cable tightly.

Description	Possible reasons and solutions
Wind turbine is in “Brake” status.	<ul style="list-style-type: none"> - If it breaks automatically, wait the wind turbine recover. - if it breaks manually, press the button for 5s to release the brake status.

Description	Possible reasons and solutions
The solar panel is connected wrongly to the controller.	Reconnect the cables.

Description	Possible reasons and solutions
Solar Panel output voltage is not in accordance with the system voltage.	Check the Solar Panel output and the system parameters.

Description	Possible reasons and solutions
Battery is already fully charged.	See if the battery has reached its over voltage point.

9. WARRANTY

The **Hybrid Boost Charge Controller** is designed to be in good working order, but if it is found to be defective within the warranty period, repair service will be provided free of charge by Kab Connect Unip. Lda.

Hybrid Boost Charge Controller	Period of warranty
	24 months

The limited warranty begins on the purchase date.

Free repair service may only be obtained by providing the warranty card and original purchase invoice issued to the customer by the retailer. The warranty card must state the purchaser's name and address, the retailer's name and address, the serial number and the date of purchase of the product.

If you experience any problem with your **Hybrid Boost Charge Controller**, please contact:

- Kab Connect – support@silentwind.com
- Authorized service dealers – <https://www.silentwindgenerator.com/en/silentwind-in-the-world/>

After Kab Connect is notified, the technical department will make all reasonable efforts via phone and email to ascertain the nature of the problem to determine whether any part is defective for purpose of coverage under this Limited Warranty. There is no charge for such diagnosis. Any repair or replacement will be provided only after Kab Connect diagnosis and its agreement to the defective condition.

Kab Connect Unip. Lda, reserves the right to repair free of charge the defective part or exchange free of charge the defective part with a new or refurbished part or **Hybrid Boost Charge Controller** that is new or equivalent to new in performance and reliability and is at least functionally equivalent to the original **Hybrid Boost Charge Controller** part.

Any costs of secure transportation of the product to Kab Connect Unip.,Lda authorized service partners will be borne by the customer. Repaired or replaced **Hybrid Boost Charge Controller** and replacement part will be delivered to the customer at Kab Connect Unip.,Lda expense.

If a warranty claim is invalid for any reason, the customer will be informed of the repair and return freight charges for prior approval. If the customer refuses to approve repair charges, return freight charges may apply.

When a **Hybrid Boost Charge Controller** part is replaced for a new or remanufactured part, such new or remanufactured part becomes customer's property and replaced part becomes Kab Connect Unip.,Lda property. Customer property remaining at Kab Connect Unip.,Lda repairs facilities for more than ninety (90) days without required customer approval of return freight charges, becomes the property of Kab Connect Unip.,Lda

Kab Connect Unip.,Lda does not warrant the following:

- Defects caused by modifications carried out without approval.
- Damage caused by improper use, handling or operation, in particular defects caused by improper installation and installation on inadequate masts or support structures.
- Accidents or disasters or any cause, including but not limited to lightning, flooding, fire etc.
- Costs for disassembly and reassembly of the product to enable shipment for warranty reasons

Disclaimer of Warranty

This Limited Warranty gives you specific legal rights, and you may also have other rights which vary from country to country and state to state. TO THE EXTENT PERMITTED BY LAW, THIS EXPRESS LIMITED WARRANTY AND THE REMEDIES SET FORTH ABOVE ARE EXCLUSIVE AND IN LIEU OF ALL OTHER WARRANTIES, REMEDIES AND CONDITIONS, WHETHER ORAL, WRITTEN, STATUTORY, EXPRESS OR IMPLIED. AS PERMITTED BY APPLICABLE LAW, Kab Connect Unip.,Lda. DISCLAIMS ANY AND ALL STATUTORY OR IMPLIED WARRANTIES, INCLUDING, WITHOUT LIMITATION, THE IMPLIED WARRANTIES OF FITNESS FOR A PARTICULAR PURPOSE, MERCHANTABILITY, NON-INFRINGEMENT AND WARRANTIES AGAINST HIDDEN OR LATENT DEFECTS. IF Kab Connect Unip.,Lda. CANNOT LAWFULLY DISCLAIM STATUTORY OR IMPLIED WARRANTIES THEN, TO THE EXTENT PERMITTED BY LAW, ALL SUCH WARRANTIES SHALL BE LIMITED IN DURATION TO THE DURATION OF THIS EXPRESS LIMITED WARRANTY. Kab Connect Unip.,Lda does not grant to any person or entity (including its field representatives, dealers or distributors) the authority to create for it any obligation or liability in connection with your [Hybrid Boost Charge Controller](#). Limitation of Liability EXCEPT AS PROVIDED IN THIS EXPRESS LIMITED WARRANTY AND TO THE MAXIMUM EXTENT PERMITTED BY LAW, UNDER NO CIRCUMSTANCES WILL Kab Connect Unip.,Lda, OR ITS AFFILIATES, SUPPLIERS, DEALERS, DIRECTORS, OFFICERS, EMPLOYEES, OR AGENTS (THE "RELEASED PARTIES") BE LIABLE OR RESPONSIBLE FOR, EVEN IF SUCH RELEASED PARTY HAS BEEN ADVISED OF THE POSSIBILITY OF SUCH DAMAGE, ANY DIRECT, SPECIAL, INCIDENTAL OR CONSEQUENTIAL DAMAGES RESULTING FROM ANY BREACH OF WARRANTY OR CONDITION, OR UNDER ANY OTHER LEGAL THEORY OR FORM OF ACTION (WHETHER IN CONTRACT, TORT (INCLUDING NEGLIGENCE), STRICT LIABILITY OR OTHERWISE), INCLUDING, BUT NOT LIMITED TO, ANY LOSS OF USE, INTERRUPTION OF OR LOSS OF BUSINESS, LOST OF ACTUAL OR ANTICIPATED PROFITS (INCLUDING LOSS OF PROFITS ON CONTRACTS), LOSS OF REVENUE, LOSS OF THE USE OF MONEY, LOSS OF ANTICIPATED SAVINGS, LOSS OF OPPORTUNITY, LOSS OF GOODWILL, LOSS OF REPUTATION, LOSS OF, DAMAGE TO OR CORRUPTION OF DATA, OR ANY INDIRECT OR CONSEQUENTIAL DAMAGES HOWEVER CAUSED, INCLUDING THE REPLACEMENT OF EQUIPMENT AND PROPERTY, BODILY INJURY OR DEATH.

(Note: some states do not allow the exclusion or limitation of incidental or consequential damages, so these limitations may not apply to you.) The total cumulative liability to Customer, from all causes of action and all theories of liability, will be limited to and will not exceed the purchase price of the [Hybrid Boost Charge Controller](#) paid by Customer.

9.1 WARRANTY CARD

Owners Name	
Purchaser Address	
Purchase Date	
Hybrid Boost Charge Controller serial number	
Retailer Name	
Retailer Address	

9. AFTER-SALES SERVICE (*)

Before requesting after-sales support, please read the user manuals carefully. Check also for our troubleshooting documents at our download section. Check regularly for updates.

The requests must be done were you bought the **SILENTWIND Pro**.

If for some reason the request is done directly to **SILENTWIND**, it will be first submitted for approval.

The requests can be done through our online Helpdesk platform at: <https://silentwind.vhdeu.com> or sending an email to: support@silentwind.com or for sales: sales@silentwind.com .

To avoid any delays, please fill all necessary information to track the problem and validate the warranty if needed.

9.3 ONLINE SUPPORT

Use our online ticket support for a faster response!

Please always provide the above information requests to speed up your claim.

You can access directly to our support portal at <https://silentwind.vhdeu.com/index.php> or you can send an email to support@silentwind.com.

For sales, you can use our support portal and choose the sales department, or you can send an email to sales@silentwind.com.

